



VMU140055LP8xxB



33" LP-LINEARHO DC MODULE, 1400mA MAX CURRENT

- Low Profile design, no magnets
- Direct mount to luminaire housing
- Superior thermal performance than standard LinearHO
- Higher aluminum material density
- Extruded Aluminum material for thermal management
- High lumen, high efficacy
- Accessories: Diffused lens compatible
- For use in UL Class 2 lighting systems
- Suitable for DLC applications: L70>60,000hrs / L90=40,000hrs
- Meets UL8750 recognized
- RoHS compliant
- The module is supplied by short circuit proof SELV controlgear

General Specifications

	Min.	Typical	Max.
Input Voltage ^①	32VDC	33.8VDC	39VDC
Input Current ^①	150mA	700mA	1400mA
Input Power ^①	4.8W	23.7W	55W
Initial Lumens @4000K / 80CRI	1,051 lumens	4,736 lumens	8,656 lumens
Initial Lm/W @4000K / 80CRI	219 lm/W	200 lm/W	174 lm/W
Beam Angle	120°		
CRI	80CRI (standard), 90CRI available		
Storage Temperature Range	-40°C to 100°C / -40°F to 212°F		
Operating Temperature Range (ta)	-40°C to 55°C / -40°F to 131°F		
Maximum Case Temperature (Tc)	L70: Tc max 105°C (Ts=110°C) / L90: Tc max 105°C (Ts=110°C)		
Estimated Lumen Maintenance ^②	L70: >60,000Hrs / L90: 40,000Hrs		
Color Consistency	Binning per ANSI C78.377-2015 @ 25°C; 3 SDCM		
Overall Size	33" L x 1.26" W x 0.29" H (840mm x 32mm x 7.4mm)		
PCB Material / Thermal Conductivity	MCPCB (Aluminum Clad)/ 1.5W / mK		
Extruded Material / Finish	Aluminum/surface treatment with Anodic Oxidation		
LED Quantity	108pcs.		
Module Weight	213g / 0.47lb		
PCB Part Number	PTL031C01M1		
Maximum Screw Installation Torque	25 inch - ounces		
Connector Type	WAGO #2060-452 / 998-404 (2 pin connector)		
Packaging: Master Carton	40pcs.		
Thermal Feedback	Not Available		
Safety/Compliance	cURus (File # E351548) Suitable for UL Class 2 Lighting Systems RoHS Compliant Dry and Damp Location CE (IEC 62031: 2008. AMD1: 2012, AMD2: 2014) SELV		
Energy Efficiency Label (EEI-Label)	A++		
Warranty	5 years @ Max. Tc from the date of manufacture		

^①Nominal ratings. Performance based on Tc mod = 25°C. See thermal de-rating chart (pg. 3) for higher temperature operation

^②TM-21 Reported Numbers



VMU140055LP8xxB



Electrical and Optical Specifications

LP-LinearHO Module Part Number	Number of LED	Input Current	Nom. Forward Voltage (VDC)	Nom. Rated Power	Max. Fwd. Voltage	Max. Rated Power	Nom. Lum. Flux @4000K/80 CRI	Nom. Efficacy @4000K/80 CRI
VMU140055LP8xxB	108	150mA	32.0V	4.8W	33V	5W	1051 lm	219 lm/W
		200mA	32.0V	6.4W	33V	7W	1399 lm	219 lm/W
		250mA	32.4V	8.1W	34V	8W	1743 lm	215 lm/W
		300mA	32.3V	9.7W	34V	10W	2087 lm	215 lm/W
		350mA	32.8V	11.5W	34V	12W	2435 lm	212 lm/W
		400mA	32.8V	13.1W	34V	14W	2766 lm	211 lm/W
		450mA	33.1V	14.9W	35V	16W	3100 lm	208 lm/W
		500mA	33.2V	16.6W	35V	17W	3435 lm	207 lm/W
		525mA	33.3V	17.5W	35V	18W	3629 lm	207 lm/W
		550mA	33.3V	18.3W	35V	19W	3765 lm	206 lm/W
		600mA	33.5V	20.1W	35V	21W	4092 lm	204 lm/W
		650mA	33.7V	21.9W	36V	23W	4414 lm	202 lm/W
		700mA	33.8V	23.7W	36V	25W	4736 lm	200 lm/W
		750mA	33.9V	25.4W	36V	27W	5047 lm	199 lm/W
		800mA	34.1V	27.3W	36V	29W	5351 lm	196 lm/W
		850mA	34.1V	29.0W	37V	31W	5662 lm	195 lm/W
		900mA	34.3V	30.9W	37V	33W	5962 lm	193 lm/W
		950mA	34.4V	32.7W	37V	35W	6258 lm	191 lm/W
		1000mA	34.5V	34.5W	37V	37W	6547 lm	190 lm/W
		1050mA	34.7V	36.4W	38V	39W	6847 lm	188 lm/W
1100mA	34.8V	38.3W	38V	42W	7109 lm	186 lm/W		
1150mA	34.9V	40.1W	38V	44W	7380 lm	184 lm/W		
1200mA	35.0V	42.0W	38V	46W	7644 lm	182 lm/W		
1250mA	35.1V	43.9W	38V	48W	7903 lm	180 lm/W		
1300mA	35.2V	45.8W	39V	50W	8154 lm	178 lm/W		
1350mA	35.4V	47.8W	39V	52W	8398 lm	176 lm/W		
1400mA*	35.5V	49.7W	39V	55W	8656 lm	174 lm/W		

Luminous Flux De-Rating: CCT and CRI Multipliers

	2700K	3000K	3500K	4000K	5000K	5700K	6500K
CRI 80(R9>0)	0.929	0.955	0.968	1.000	1.013	1.006	1.000
CRI 90(R9>50)	0.776	0.801	0.821	0.863	0.869	0.865	0.863

NOTES:

- 1) Performance based on Tc mod = 25°C. See thermal de-rating chart (pg. 3) for higher temperature operation
- 2) Standard lumen output and efficacy is calculated for standard options. Reference CCT & CRI vs Luminous Flux chart for lumen ratio calculation.
- 3) Specifications are subject to change without notice.
- 4) The LED DC Module can be configured with different LED chip quantities, series and parallel design configurations to meet a specific design requirement. Contact Fulham for further assistance.
- 5) * Indicates maximum rated current. Modules may be operated at a current less than or equal to this value, below the Tc rating.
- 6) 70CRI is NOT available.



VMU140055LP8xxB



Thermal Specifications

	LP-LinearHO DC Module
Storage Temperature Range	-40 to +100°C / -40 to +212°F
Operating Ambient Temperature Range (ta)	-40 to 55°C / -40 to 131°F
Maximum Case Temperature (Tc)	L70 = 105°C (221°F) / L90 = 105°C (221°F)



Thermal De-Rating

Tc vs. Luminous Flux vs. Forward Voltage

Module Case Temperature (Tc)	Total Vf Multiplier	Luminous Flux Multiplier
25°C	1.000	1.000
30°C	0.998	0.991
35°C	0.997	0.983
40°C	0.995	0.974
45°C	0.993	0.966
50°C	0.991	0.957
55°C	0.990	0.949
60°C	0.988	0.940
65°C	0.986	0.932
70°C	0.985	0.923
75°C	0.983	0.915
80°C	0.981	0.906
85°C	0.980	0.898
90°C	0.978	0.890
95°C	0.976	0.881
100°C	0.974	0.873
105°C	0.973	0.864

Module Tc vs. Ambient (ta) vs. Module Input Current (mA)

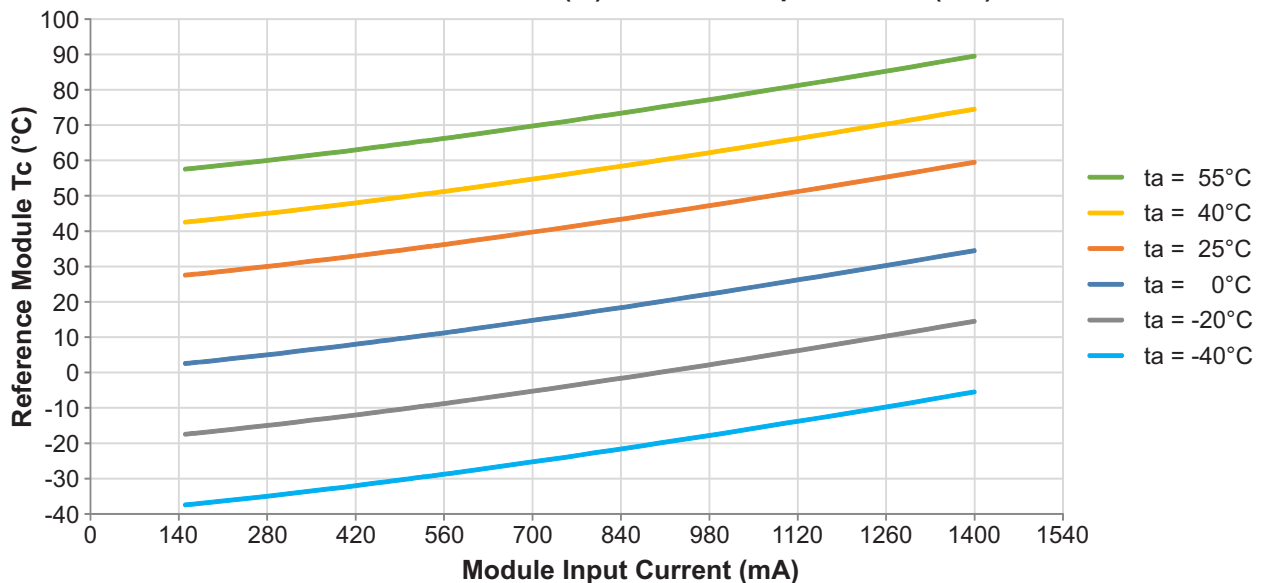

NOTES:

1) Chart "Module Tc vs. Ambient (ta) vs. Module Input Current (mA)" for reference only in an open ambient. The performance with in a luminaire will vary depending on the size and material of luminaire.



VMU140055LP8xxB



Certification Chart

Classification	Model	VMU140055LP8xxB
		YES
		YES
		YES
Energy Efficiency Label (EEI-Label)		A++
Suitable for UL Class 2 Lighting System		YES

Energy Star™ TM-21 Calculator Data

Tc Module	Reported L70	Reported L90
55°C	>60,000 Hrs	54,000 Hrs
85°C	>60,000 Hrs	46,000 Hrs
105°C	>60,000 Hrs	40,000 Hrs

Tc Module	Calculated L70	Calculated L90
55°C	180,000 Hrs	54,000 Hrs
85°C	154,000 Hrs	46,000 Hrs
105°C	133,000 Hrs	40,000 Hrs

LED Lumen & Color Maintenance Data per LM-80 Report and TM-21 Calculator

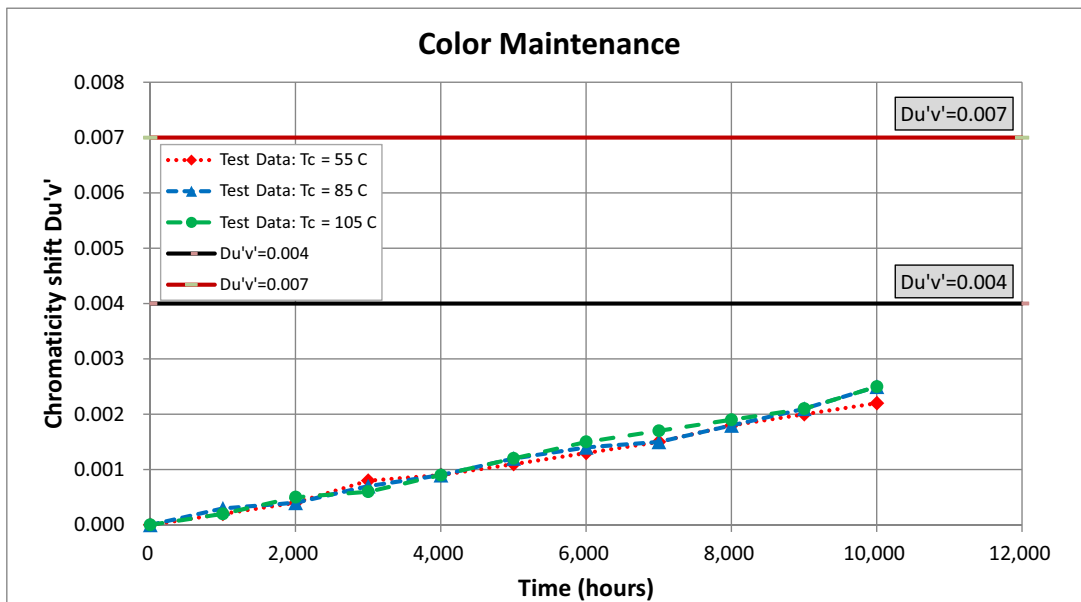
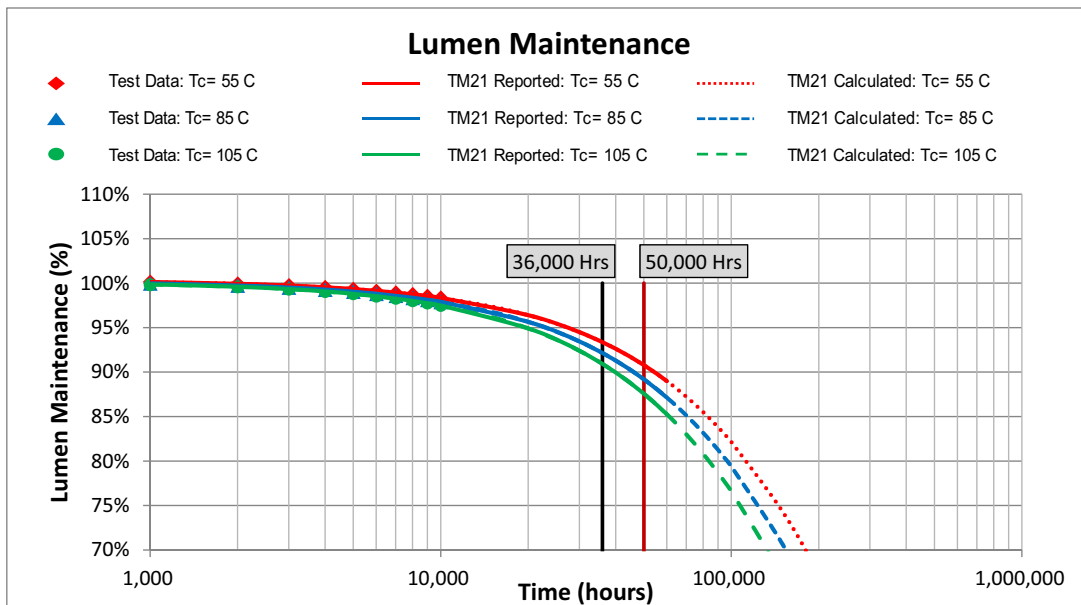



VMU140055LP8xxB



Mechanical Drawings

(Scale 1:10)

33"
[840mm]

Overall Dimensions	
Length	33" [840mm]
Width	1.26" [32mm]
Height	0.29" [7.4mm]

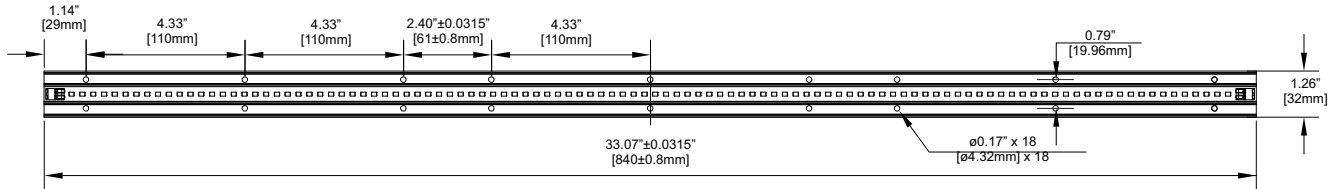

TOP VIEW

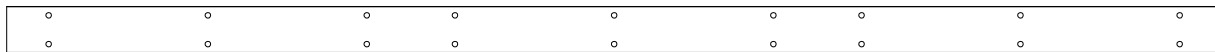

BOTTOM VIEW

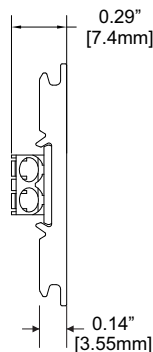

SIDE VIEW

Unmarked General Tolerance
 <4" [100mm]: ±0.0138" [±0.35mm]
 4"~11.8" [100~300mm]: ±0.0197" [±0.5mm]
 >11.8" [300mm]: ±0.0236" [±0.6mm]
 HOLES: ±0.002" [±0.05mm]



VMU140055LP8xxB



Accessories

Diffuser Lens

Fulham Part Number: **VLE-OPT-120-033D (33" Diffuser Lens - 120° Beam Angle)**

- White polycarbonate diffuser lens - 82% transmissivity at nominally rated currents.

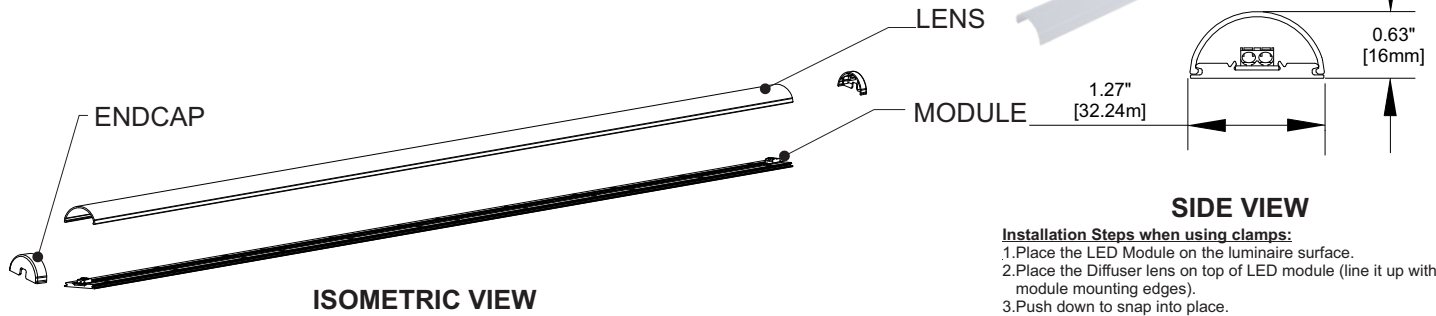

Endcap

Fulham Part Number: **VLE-OPT-120-012**

- White Polybutylene Terephthalate (PBT) end caps

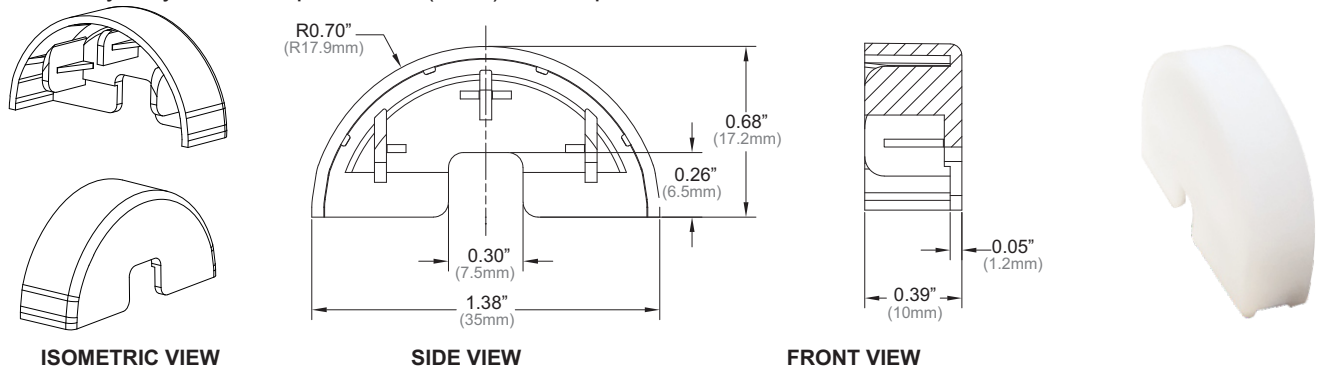

Harness

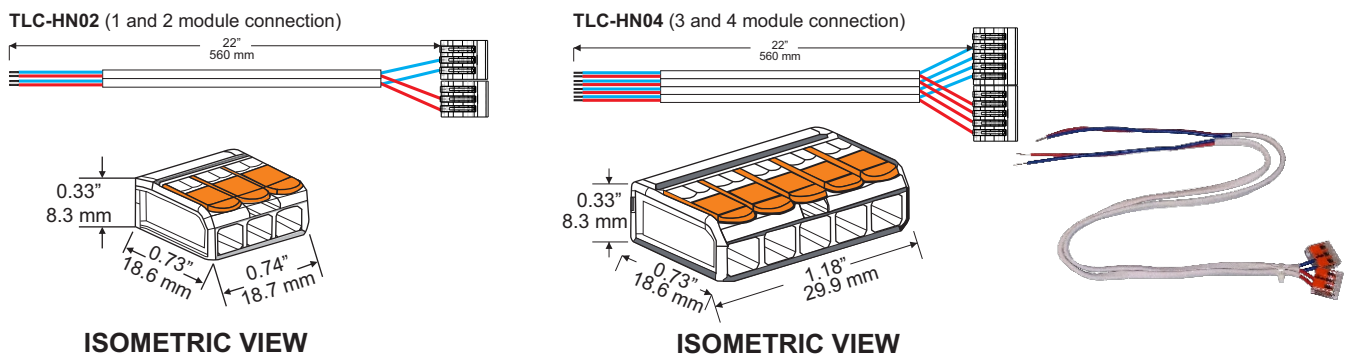

Interconnects

- Interconnect Type: WAGO Double pins to interconnect Modules (#2060-952/028-000)
- Approvals: cURus, UL 1977, and RoHS Compliant

NOTES:

- 1) Interconnects are NOT sold by Fulham.
- 2) Do not connect LinearHO Modules in parallel (end to end) if the current exceeds the maximum module rated current. This type of wiring would cause the pass-through current on the first module to exceed the rated current. This setup is in reference to wiring diagram #2 per Fulham's wiring diagram (see link on page #8). If the current is higher than the rated max, it is recommended to use wiring diagram #3.

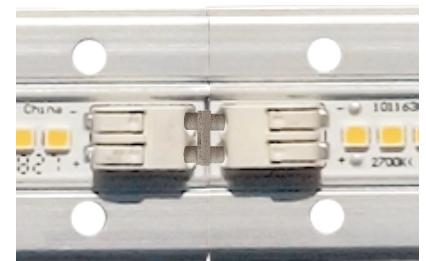

Top View



VMU140055LP8xxB



Color and Binning

Optical Spectrum

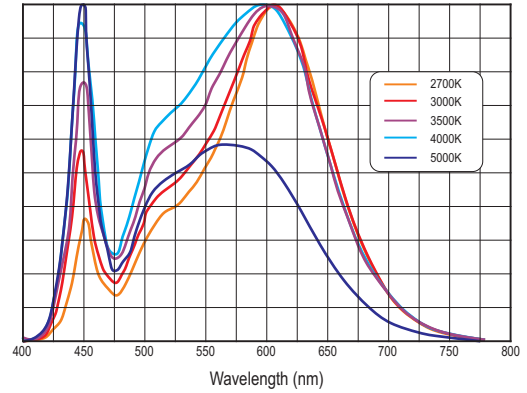
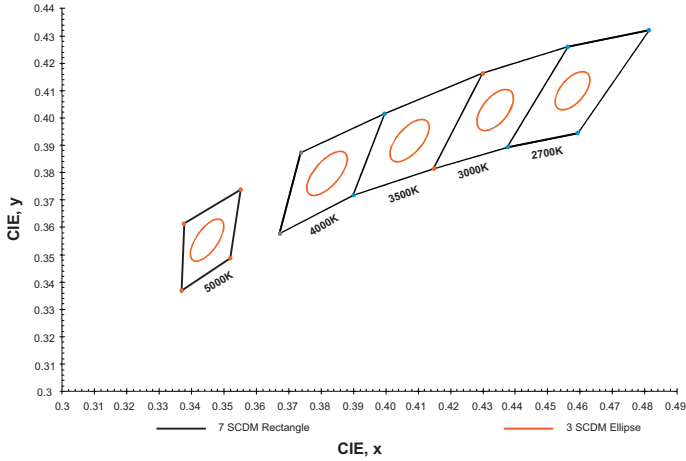

Compatible Fulham Drivers

(Please use the links below for a complete list of compatible Fulham drivers and wiring diagrams)

- LP-LinearHO System Combination:
- Fulham's Wiring Diagrams: <https://cdn.fulham.com/PDFs/SpecSheets/DC-Modules-Wiring-Diagrams.pdf>
- Compatible with Fulham Hotspot EM Systems.

NOTES:

- 1) The Color and Binning and Optical Spectrum charts are for reference only. For more detailed info, contact factory.
- 2) Reference Samsung Chromaticity Diagram for Color and Binning. Binning per ANSI C78.377-2015 @ 25°C; 3 SDCM.
- 3) The Optical Spectrum values vary depending on product type and color rank.
- 4) Driver not included.
- 5) Do not connect LinearHO Modules in parallel (end to end) if the current exceeds the maximum module rated current. This type of wiring would cause the pass-through current on the first module to exceed the rated current. This setup is in reference to wiring diagram #2 per Fulham's wiring diagram (see the link above). If the current is higher than the rated max, it is recommended to use wiring diagram #3.



Guidelines

Termination Notes

- Connector Type: WAGO #2060-452 / 998-404 (2 pin push wire connector)
 - AWG: 24...18 solid wire
 - Strip length: 7...9mm / 0.28...0.35in
 - Connector Max amp. rating: 9 Amps.



Connector

For more detail information, please visit Wago's website: <http://www.wago.com/infomaterial/pdf/51300133.pdf>

Fastening Notes

- If fastening by screw hole a recommended screw size: 6-20 x 5/8" flat head drilling screws. Use all available screw holes to ensure good contact between back side of module and mounting surface. Refer to max specified torque for installation.
- If fastening using double-sided tape, start with clean, oil-free and dust-free surface. Peel backing and place LED module on mounting surface. Firmly press down on the module to ensure good adherence. Follow the double-side tape manufacturer's installation instructions.
- BJB P2F (Push-to-Fix) fixing elements for PCBs can be used to fasten LED modules to mounting surface. Reference BJB's website for ordering information and specific model to use: <http://www.bjb.com/index.php?pid=376706&lid=10>.
- HEYCO HEYClip Snap Rivets 9035 is recommended for fast and easy installation with clean and finish look. For more detail information, please visit Heyco website: https://www.heyco.com/Nylon_PVC_Hardware/product.cfm?product=Snap-Rivets

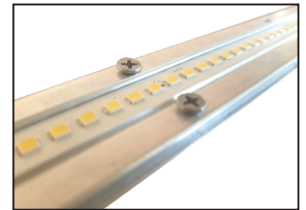

Heyco Rivet 9035

Environmental Rating / Conformal Coating

- The DC LP-LinearHO Modules have been evaluated for use in dry or damp locations only. If used in wet locations, acceptability and the need for additional evaluation shall be determined in the end product.
- Fulham's LP-LinearHO modules are available with conformal coating; made to order with MOQ and lead time will apply. The conformal coating is a silicone based material which is double sprayed on the module only (LEDs and PCB). Conformal coating is recommended for the following applications: near ocean where salt is present, constant moisture, refrigeration, continuously high humidity, or outdoor applications. An IP rating of IP64 or IP65 is achieved when the conformal coating is used, but other factors should be considered. Fulham still recommends the luminaire also meet an IP64/65 rating.

Electrostatic Sensitive Product (ESD)

- Fulham LED products should be handled with proper measures to protect against any potential ESD damage.
- When servicing, personnel should be ground and direct contact with LED should be avoided.

Thermal Management

- Proper thermal management should be employed to ensure life and reliability of product. Max Tc of module should not be exceeded.
- Use of thermal grease, paste, pad, or other material interface is highly recommended.

Polarity Notes

- DC LP-Modules are polarity sensitive.
- Ensure that "positive" from LED Driver is connected to "positive" of LED modules and that "negative" from LED Driver is connected to "negative" of LED modules.
- Polarities of modules are marked with "+" for positive and "-" for negative.



VMU140055LP8xxB



Part Number Matrix

V M U 140 055 LP 8 XX B

Product Line	Type	Control Type	Input Current	Max. Power	Design	CRI	Color Temperature	Option
V = Vizion	M = Module (UL Class 2)	U = None	140 = 1400mA Max.	055 = 55W	LP=Low Profile	Ⓢ 8 = 80 9 = 90	27 = 2700K Ⓢ 30 = 3000K Ⓢ 35 = 3500K Ⓢ 40 = 4000K Ⓢ 50 = 5000K 57 = 5700K 65 = 6500K	B = Standard Ⓢ F = 33" Conf. Coating (MTO)

Ⓢ Standard Product offering (All other options are made to order with MOQ and lead time)
 Ⓢ See page #8 for Conformal Coating information. Made to order (MTO).

Product Image: LP-LinearHO Module



TOP VIEW

Packaging

Master Carton

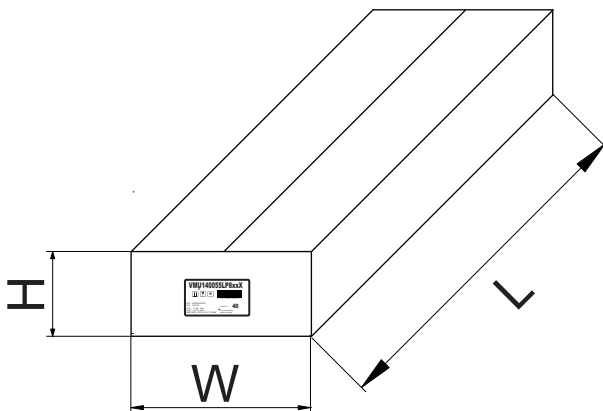

OUTER DIMENSION		
L	W	H
34.25"(870mm)	10.63"(270mm)	4.33"(110mm)
Net Weight	Gross Weight	QUANTITY
18.8 lbs. (8.53kg)	19.3 lbs. (8.75kg)	40pc.